

TRISTAN - 1189CCW

LED COMPACT - LED 825W



- **Type:** Followspot
- **Source:** LED 825W
- **Optics:** 7° to 14.5° zoom
- **Colour temperature:** Cool White
- **Standard:** 110 V North american

Followspot

Compact and powerful

With its 825W LED cool white source, Tristan followspot provides high output with a 7°-14° zoom range to rival the traditional 1800W MSR followspots, within the compact body of a 1200W model. Unique to Tristan, the motorized iris enables the creation of iris presets. It will be equally at ease in front-of-house, truss and backlight positions.

Features

- **Motorised fully closing iris:** makes it possible to store presets for fast cues
- **Universal adjustable gobo holder:** "A" size glass and metal gobos
- **Ergonomic dimmer control:** one-handed dim, pan and tilt
- **Local control:** light intensity and beam size (iris) adjustment through built-in potentiometers
- **Frost filter:** on flip lever for quick soft-edge beam effect
- **Internal glass filter holder:** long term use of durable coloured, dichroic or textured glass
- **Individually removable colour frame:** gels replaced easily while colour cassette remains in place
- **Colour changer:** 6-way, self-cancelling boomerang colour-changer
- **Optional Colour correction (1/2 CTO):** on flip lever for fast change
- **Remote display:** an optional second display can be connected anywhere on the unit to have simultaneous view of the stage and iris / intensity values
- **Remote controllers:** optional controllers can be connected to operate the followspot from any position (back, side...)
- **Adjustable response time:** choice of fast or slow dimming for tungsten-like simulation - adjustment by DMX protocol
- **Ethernet-DMX node:** data IN through RJ45 connector; data OUT through DMX for daisy chaining
- **Universal data control:** compatible with DMX, RDM, Art-Net, sACN protocols
- **Remote setup:** all parameters can be adjusted by RDM protocol or by web interface
- **PWM adjustment:** choice of different PWM dimming frequencies - continuous mode available
- **Advanced Ethernet node functionalities:** compatible with RDM, LLRP, Zeroconf protocols
- **Local setup:** DMX address and mode, dimming curve and response time through 4-button display with automatic light switch-off
- **Dimming parameters:** choice of square or linear dimming curves
- **DMX:** 8 or 16 bit dimming, iris and strobe function
- **Fine balance:** precision positioning and smooth operation even with the smallest movements
- **Stand:** perfectly weighted for maximum stability with smooth rotation for optimum performance. Easy set up; triple safety system for extra security

Optical

- **Long life:** outstanding operational lifetime expectation, no need to replace lamps, low maintenance
- **Native high CRI LED source:** CRI > 90 - perfect for performer illumination - no need for correction filter
- **High output:** up to 26 000 lumens. Capable of matching the lumen output of MSR 1800W Victor followspot
- **Gobo :** excellent gobo projection
- **Optical quality:** smooth flat beam, no hot spot
- **Variable zoom optics:** sharp focus at every beam angle. Independent control of image size and focus.
- **Electronic dimmer:** dimming without clipping or cut-out at low intensity levels; high quality smoothing
- **No colour shift:** colour temperature remains the same when dimming

Construction

- **Made in France :** fully manufactured in Robert Juliat premises retaining complete control over all aspects of quality
- **PSU:** built-in electronic flicker-free power supply for easy, plug-and-play installation
- **Power connectors:** compatible powerCON® TRUE1 IN and OUT connectors for daisy chaining
- **Silent-running cooling fans:** ideal for TV studios and opera houses
- **Electronic thermal management system:** ensures maximum performance of the system without any risk of overheating
- **3 cooling modes available:** includes a silent mode for perfect integration in concert halls
- **Bodywork:** strong sheet metal construction for durability
- **Ergonomic wrap-around handle:** comfort, safety and practicality from all operating positions
- **Moving parts:** smooth at all times, even when hot
- **Captive knobs and handles:** additional security when working at height or in transit
- **Easy access to all parts:** easy cleaning and maintenance

Picture:1189

DSEN433_1189CCW_Preliminary - 08/11/2024 - Preliminary data
Robert Juliat reserves the right to change or alter any of the items detailed on this page, to increase or improve manufacturing techniques without prior notice.
Robert Juliat S.A.S., 32 rue de Beaumont, 60530 Fresnoy-en-Thelle - France
Telephone : +33 (0)3 44 26 51 89 - info@robertjuliat.fr - www.robertjuliat.com



ROBERT JULIAT

- Lamp type: LED
- Power: 825 W

LED specifications	Power *	Lumen output*	Colour temperature*	Life*	CRI* (min)
TCW01	825 W	47 000 lm	6500K	30 000 h	90

(*) manufacturer's data

Optics

Characteristics

- Type: Zoom
- Range: 7° to 14.5° (Field angle)
- Focal length: - mm

Gel filter

- Shape: Circle
- Standard size: 210 mm (8.3 in)

Gobo

- Size: A
- Material: Metal
Glass

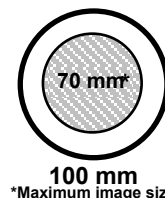

Photometrics (Photometrics report(s) available at the end of the document)

optics: 7°-14,5° / Standard

• Optics @ 7°

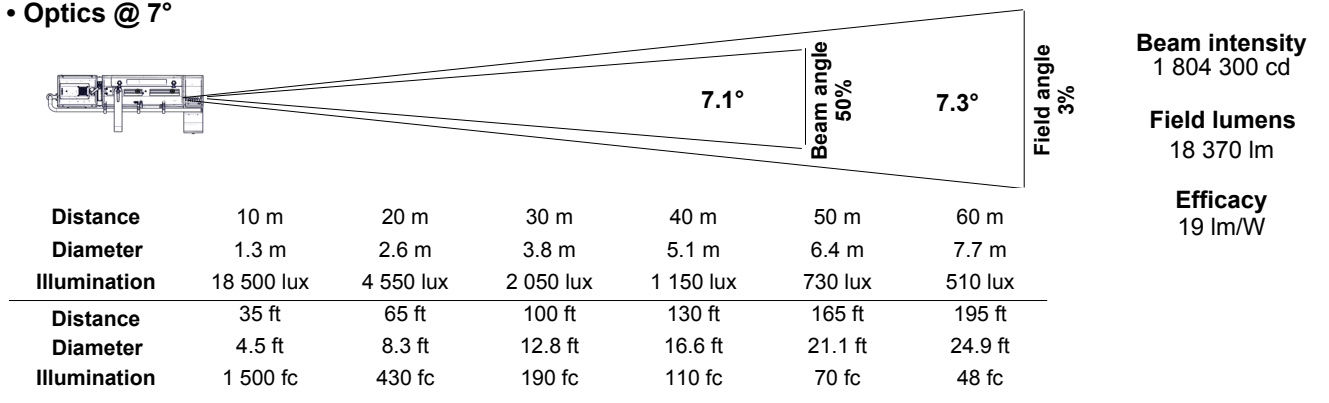

• Optics @ 14.5°

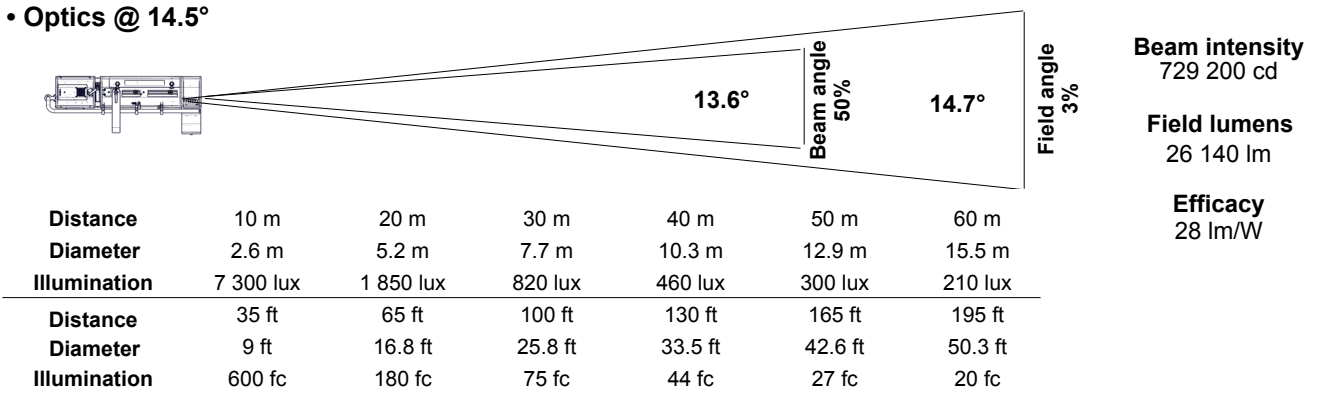

Remote control

- Data protocol: USITT DMX512-A
RDM / Art-Net / sACN

- Data IN connector: 5 pins XLR male + etherCON RJ45
- Data OUT connector: 5 pins XLR female



• DMX chart:

Mode 1 (1 channels)	Mode 2 (6 channels)	Mode 3 (8 channels)	Mode 4 (10 channels)
Dimmer	Dimmer	Dimmer	Dimmer @16
	Dimmer fine	Dimmer fine	Master dimmer @16
	Strobe duration	Master dimmer	Strobe duration
	Strobe speed	Master dimmer fine	Strobe speed
	Response time	Strobe duration	Response time
	Control mode	Strobe speed	Control mode
		Response time	Iris
		Control mode	iris mode

Dimensions and weight

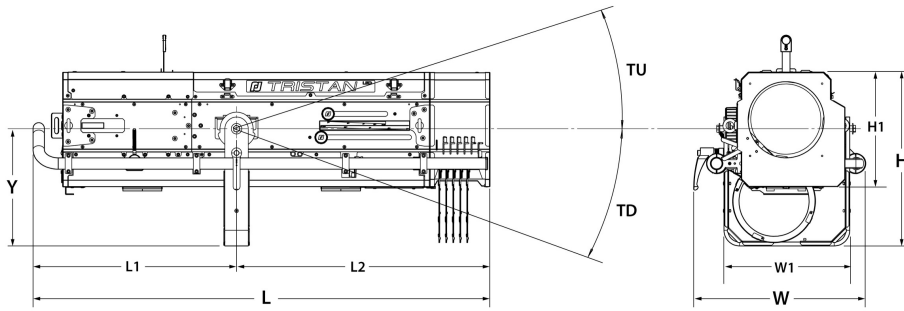

Weight: 39 kg (85.8 lbs)

Height	Length	Width	Yoke	Tilt
H= 445 mm (17.5 in)	L= 1174 mm (46.2 in)	W= 435 mm (17.1 in)	Y= 304 mm (12 in)	
H1= 294 mm (11.6 in)	L1= 523 mm (20.6 in)	W1= 323 mm (12.7 in)		
	L2= 651 mm (25.6 in)	W2= 250 mm (9.8 in)		

Shipping

- **Weight :** 53 kg (116.6 lbs)
- **Volume :** .32 m³ (11.3 ft³)

Installation

- **Minimum distance to illuminated surface:** 2.4 m (7.9 ft)
- **Operating position:**



Construction

- **Housing:** Steel sheet - Aluminium
- **Colour:** Black
- **Cooling:** Variable fans
- **Maximum ambient temperature (Ta):** 40°C (104°F)
- **Maximum case temperature (Tc):** °C (°F)
- **Total heat dissipation:** 3 379 BTU/h
- **Ingress Protection (IP) rating:** IP20

Electrical compatibility

- 220/230 V - 50 Hz
- 245 V - 50 Hz
- 110/120 V - 60 Hz
- 208 V - 60 Hz
- 220/230 V - 60 Hz
- 100 V - 50 Hz
- 100 V - 60 Hz
- Selector: automatic detection

Power input



- **Type:** removable power cord with compatible powerCON® TRUE1 connector (included)
- **Cable:** 14 AWG SJ type (UL/CSA)
- **Length:** 1.5 m (4.9 ft)
- **Power connector:** without connector

Power consumption

Voltage	Frequency	Current	Power	Power factor
110 V	60 Hz	9.27 A	990 W	0.99
208 V	60 Hz	4.86 A	961 W	0.96
100 V	60 Hz	10.31 A	1000 W	0.98

Power Supply Unit

- **PSU:** Internal - Electronic PSU - Flicker free with PFC
- **Control:** Local / DMX
- **Protection:** Mains: 2x 16A 1P1D breaker - UL /

Warranty

- **Fixture: 3 years**
See General Sales Condition on website

Approvals

















Model

1189CCW

LED 825W Followspot - 1189CCW Tristan - Cool White - 7/14.5° - North american standard

Options

Accessories

PF1011	Ø210 mm metal filter holder 6 included	
SGUP2	Universal "A" size gobo-holder (metal, glass, frosted glass) 1 included	
VDM100	Ø97mm frosted glass with holder 1 included	
M270/2B	6 ways "boomerang" colour changer 1 included	
GT4000	Tripod stand with safety chain - SWL: 130 Kg - max. height: 1030 mm - Weight: 7.91 Kg	
GT4000RSM	Tripod stand with ball head rotation with security chain and SpotMe PAN sensor - SWL: 130 Kg - max. height: 1030 mm	
GT4000S	Tripod stand without safety chain - SWL: 130 Kg - max. height: 1030 mm - Weight: 8.65 Kg	
JPP	Monopod stand for overhead followspot - Weight: 3.6 Kg	
T1000	TV spigot with followspots swivel head - Weight: 1.82 Kg	
T4000	Followspot mount for Ø50mm pipe (suspension or overhead) - SWL= 100 Kg - Weight: 4.88 Kg	
T4000RSM	Followspot mount with ball head rotation and SpotMe PAN sensor - SWL = 100 Kg - Weight: 8.53 Kg	
FCM100R	Ø97mm 1/2 CTO correction filter (Rosco #3408) with holder	
VD120	120x120mm frosted glass	
BK/E1	Extra weight kit for BK1 (0,5 Kg) - Weight: 0.5 Kg	
BK1	Followspot balancing kit (including 1 Kg counterweights) - Weight:	

2.05 Kg



Kit TELRAD

Telrad followspot sight with raiser and universal mounting kit -
Weight: 1.23 Kg



SDUP

Followspot cue sheet holder with universal mounting kit



TCSM

SpotMe calibration tool kit



Maestro

Maestro server for SpotMe - rackable unit: 1U - half 19" - Weight:
1.2 Kg



SMS

SpotMe server + 2 sensor cables + flight case



• Optics @ 7°

Field lumens	Beam lumens	Efficacy	Beam intensity	CCT	Delta uv
18 370 Lm	18 130 Lm	19 Lm/W	1 804 300 Cd	6 710 K	-0.0042

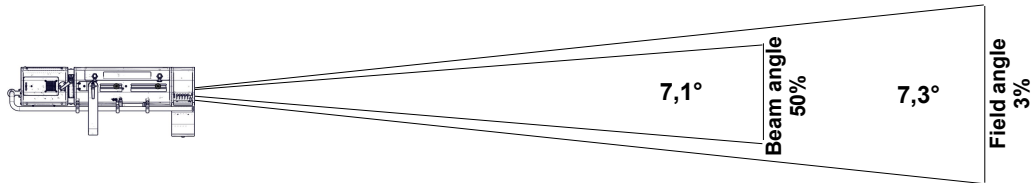

Distance	10 m	20 m	30 m	40 m	50 m	60 m
Field diameter	1,3 m	2,6 m	3,8 m	5,1 m	6,4 m	7,7 m
Illumination	18 500 lux	4 550 lux	2 050 lux	1 150 lux	730 lux	510 lux
Distance	35 ft	65 ft	100 ft	130 ft	165 ft	195 ft
Field diameter	4,5 ft	8,3 ft	12,8 ft	16,6 ft	21,1 ft	24,9 ft
Illumination	1 500 fc	430 fc	190 fc	110 fc	70 fc	48 fc

• Optics @ 11°

Field lumens	Beam lumens	Efficacy	Beam intensity	CCT	Delta uv
26 240 Lm	25 630 Lm	28 Lm/W	1 165 000 Cd	6 700 K	-0.0042

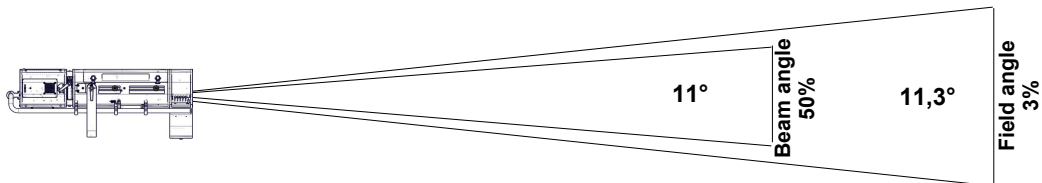

Distance	10 m	20 m	30 m	40 m	50 m	60 m
Field diameter	2 m	4 m	5,9 m	7,9 m	9,9 m	11,9 m
Illumination	12 000 lux	2 950 lux	1 300 lux	730 lux	470 lux	330 lux
Distance	35 ft	65 ft	100 ft	130 ft	165 ft	195 ft
Field diameter	6,9 ft	12,9 ft	19,8 ft	25,7 ft	32,6 ft	38,6 ft
Illumination	960 fc	280 fc	120 fc	70 fc	43 fc	31 fc

• Optics @ 14,5°

Field lumens	Beam lumens	Efficacy	Beam intensity	CCT	Delta uv
26 140 Lm	23 960 Lm	28 Lm/W	729 200 Cd	6 690 K	-0.0042

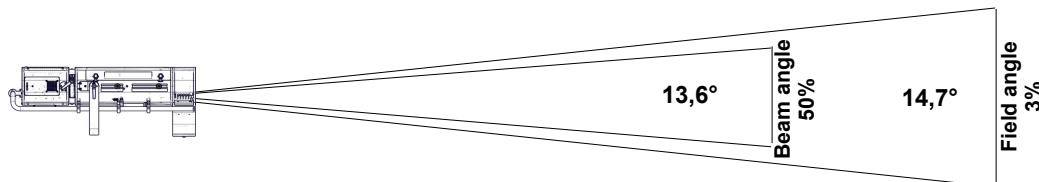

Distance	10 m	20 m	30 m	40 m	50 m	60 m
Field diameter	2,6 m	5,2 m	7,7 m	10,3 m	12,9 m	15,5 m
Illumination	7 300 lux	1 850 lux	820 lux	460 lux	300 lux	210 lux
Distance	35 ft	65 ft	100 ft	130 ft	165 ft	195 ft
Field diameter	9 ft	16,8 ft	25,8 ft	33,5 ft	42,6 ft	50,3 ft
Illumination	600 fc	180 fc	75 fc	44 fc	27 fc	20 fc

Light quality report

CCT	DeltaUV	CRI Ra	CRI R9	CQS Qa	TM30-18 Rf	TM30-18 Rg	TLCI
6 700K	-0.0041	94	79	89	90	100	92

CRI - CIE Colour Rendering Index

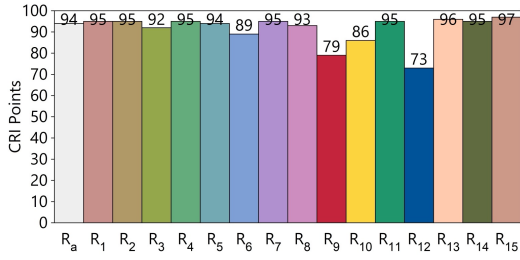

TLCI - Television Lighting Consistency Index

Test : CCT = D6694 (-1.4)
 TLCI-2012 : 92 (D6694)

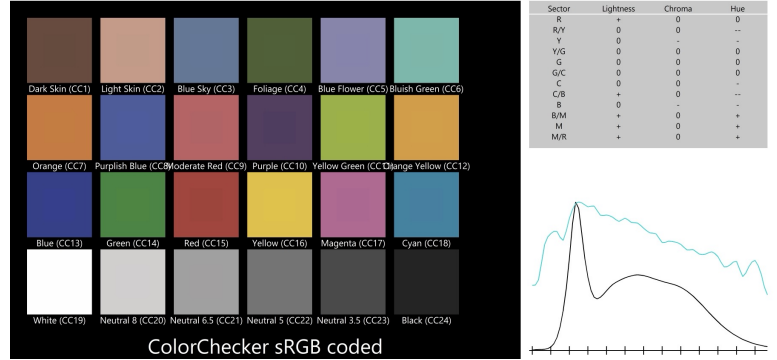

CQS - NIST Colour Quality Scale

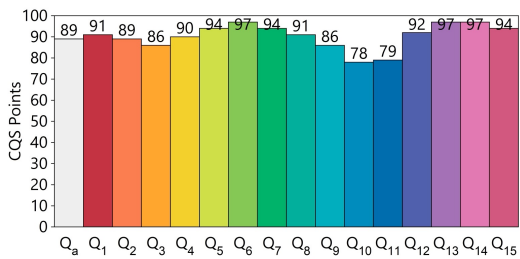

ANSI/IES TM-30-18 Colour Rendition Report

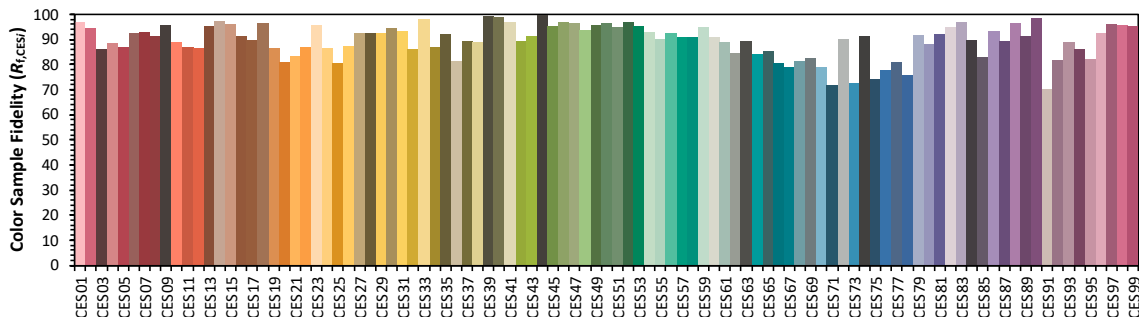
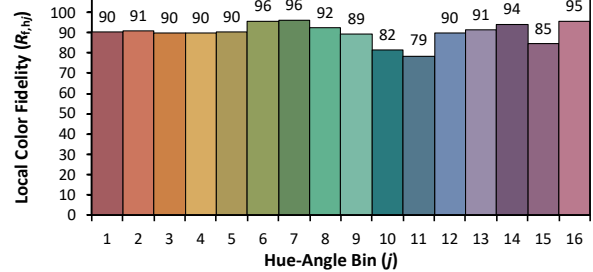
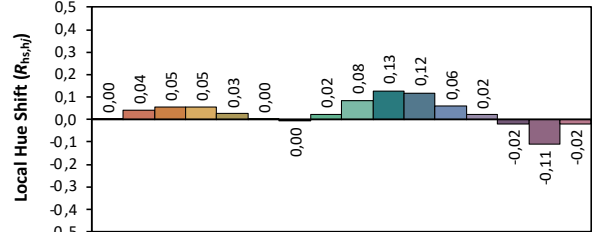
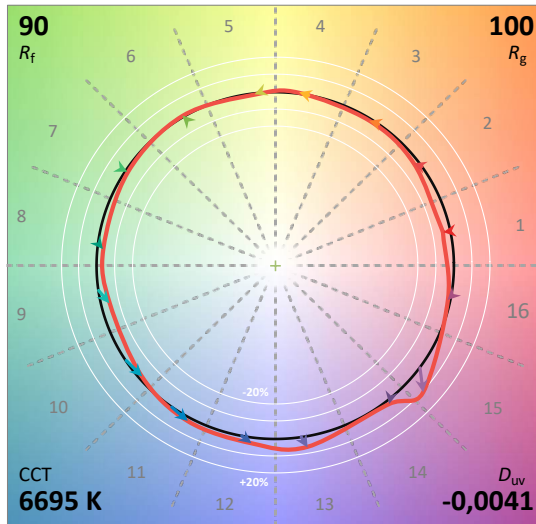
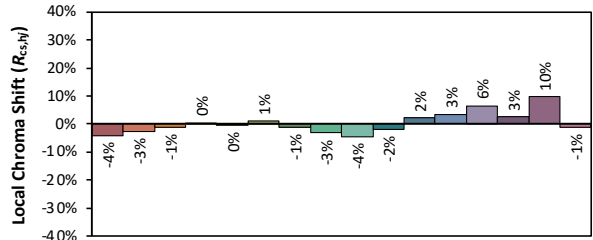
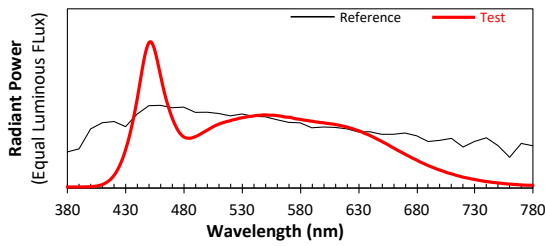

Colours are for visual orientation purposes only. Created with the IES TM-30-18 Calculator Version 2.00